

# Ecophon Hygiene Performance™ Plus A

Ecophon Hygiene Performance™ Plus A has an exposed grid with fully sealed robust Hygiene Performance™ Plus A tiles and suitable for humid areas. The ceiling withstands advanced cleaning, such as steam and high/low pressure washing on a regular basis. The surface is resistant to common detergents and disinfectants.



Orly, Landskrona, Sweden

## SYSTEM RANGE

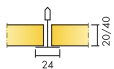

Size, mm	600x600	600x600	1200x600	1200x600
T24	•	•	•	•
Thickness (THK)	20	40	20	40
Inst. Diagr.	M466	M466	M466	M466

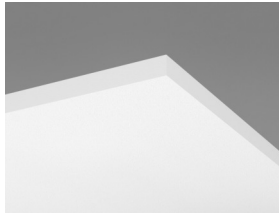

Hygiene Performance Plus A tile

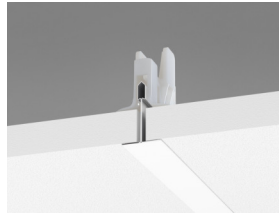

Hygiene Performance Plus A C3 section with Connect Hygiene Clip 20



Hygiene Performance Plus A system



## Acoustic

### Sound Absorption:

Test results according to EN ISO 354. Classification according to EN ISO 11654.

$\alpha_p$ , Practical sound absorption coefficient

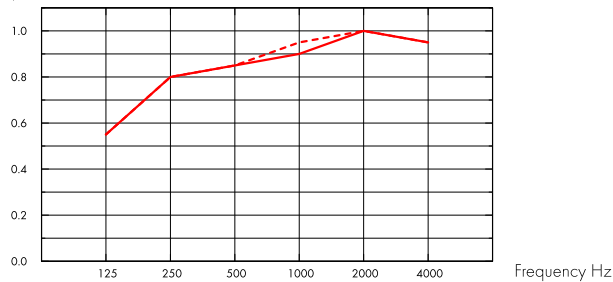

- Hygiene Performance Plus A 20 mm, 200 mm o.d.s.
- - Hygiene Performance Plus A 40 mm, 200 mm o.d.s.

THK mm	o.d.s. mm	$\alpha_p$ , Practical sound absorption coefficient						$\alpha_w$	Sound absorption class
		125 Hz	250 Hz	500 Hz	1000 Hz	2000 Hz	4000 Hz		
20	200	0.55	0.80	0.85	0.90	1.00	0.95	0.90	A
40	200	0.55	0.80	0.85	0.95	1.00	0.95	0.95	A



## Indoor Air Quality

Certificate / Label

Eurofins Indoor Air Comfort®

IAC

French VOC

A

Finnish M1

•



## Environmental Footprint

Kg CO<sub>2</sub> equiv/m<sup>2</sup>: 4,2 From family EPD in conformity with ISO 14025 / EN 15804



## Circularity

Minimum post-consumer recycled content

44%

Recyclability

Fully recyclable



## Fire safety

Country	Standard	Class
Europe	EN 13501-1	A2-s1,d0

The glass wool core of the tiles is tested and classified as non-combustible according to EN ISO 1182.



## Humidity Resistance

Class C, relative humidity 95% and 30°C, according to EN 13964:2014



## Visual appearance

White 500, nearest NCS colour sample S 0500-N, 84% light reflectance.



## Cleanability

Daily dusting and vacuum cleaning. Weekly wet wiping.



## Advanced Cleanability

High and low pressure cleaning with water and steam cleaning. Withstand use of hydrogen peroxide vapor.



## Surface Endurance

Product tested according to ISO 11998, and withstand 200 cycles.



## Chemical resistance/Disinfection

Chemical	Active Substance	Concentration
Actichlor plus	NaDCC (Sodium Dichloroisocyanurate)	1%
LifeClean	Chlorine dioxide	Undiluted
Etanol	Etanol	70%
Chlorine	Sodium Hypochlorite solution	2,5%
Virkon S	Dipotassium peroxodisulphate; Sulphamic acid	1%
Isopropanol	Isopropyl Alcohol	70%
Oxivir Excel	Hydrogen peroxide	0,5%
Sumabac D10	Quaternary ammonium compound, Sodium carbonate	1%
Suredis VT1	n-(3-aminopropyl)-n-dodecylpropan-1,3-diamin	1%
Enduro Chlor VE5	Potassium hydroxide	1,5%
Acipusfoam VF59	Nitric Acid	5%

Tested according to ISO 11998 and withstand the following chemicals or disinfectants.



## Mould and Bacterial Resistance

Standard/Method	
ISO 846 A	0
ISO 846 C	0



## Clean Room

Standard	Standard/Method	Class
ISO 14644	Particle cleanliness class	ISO 4
NF S 90-351	Microbiological class	M1/area 4
NF S 90-351	Particle elimination kinetics	CP(0,5) 5



## Accessibility

The tiles are demountable. Minimum demounting depth according to installation diagram. The tiles are secured using clips to allow for effective cleaning. The clips are easily removable from above the ceiling. An easy-to-open Connect Inspection hatch is available to simplify access to the ceiling void.



## System weight

The weight of the system (including suspension grid) should be approximately 3,5 kg/m<sup>2</sup> for 20mm thickness and 5 kg/m<sup>2</sup> for 40mm thickness.



## Mechanical properties

See table about Max live load and Min load bearing capacity and Functional demands, Mechanical properties at [www.ecophon.com](http://www.ecophon.com).



## CE

Ecophon ceiling systems are CE marked according to the European harmonized standard EN13964:2014. CE marked construction products are covered by a Declaration of Performance (DOP) which enables customers and users to easily compare performance of products available on the European market.

## INSTALLATION DIAGRAM (M466) FOR ECOPHON HYGIENE PERFORMANCE™ PLUS A C3

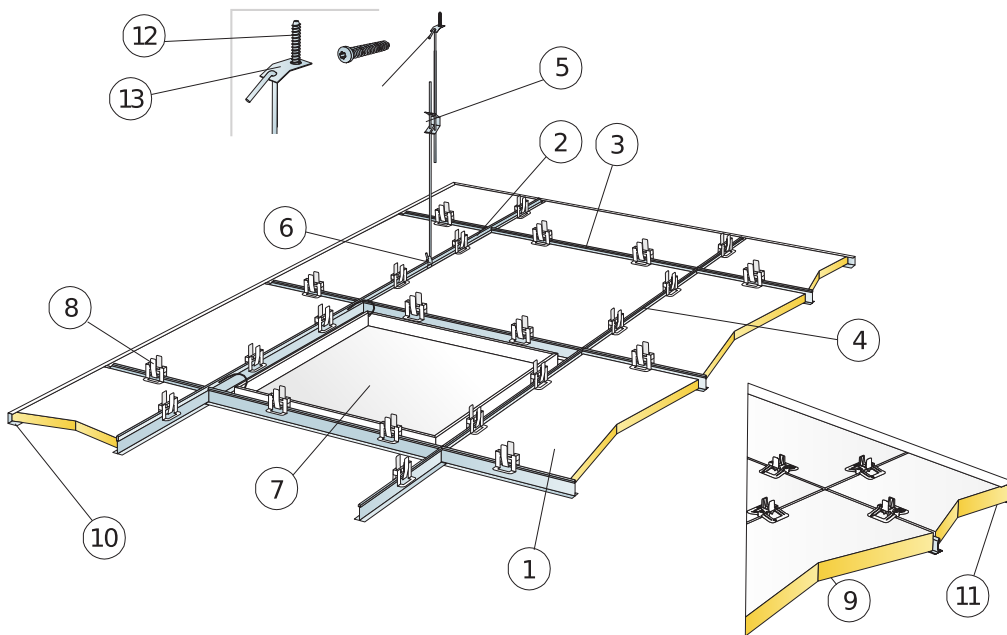

© Ecophon Group

### QUANTITY SPECIFICATION (EXCL. WASTAGE)

	Size, mm			
	600x600	600x600	1200x600	1200x600
1 Hygiene Performance Plus A	2,8/m <sup>2</sup>	2,8/m <sup>2</sup>	1,4/m <sup>2</sup>	1,4/m <sup>2</sup>
2 Connect T24 Main Runner C3, installed at 1200 mm centres	0,9m/m <sup>2</sup>	0,9m/m <sup>2</sup>	0,9m/m <sup>2</sup>	0,9m/m <sup>2</sup>
3 Connect T24 Cross Tee C3, L=1200 mm, installed at 600 mm centres	1,7m/m <sup>2</sup>	1,7m/m <sup>2</sup>	1,7m/m <sup>2</sup>	1,7m/m <sup>2</sup>
4 Connect T24 Cross Tee C3, L=600 mm	0,9m/m <sup>2</sup>	0,9m/m <sup>2</sup>	-	-
5 Connect Adjustable Hanger C3, c1200 (max distance from wall 600 mm)	0,7/m <sup>2</sup>	0,7/m <sup>2</sup>	0,7/m <sup>2</sup>	0,7/m <sup>2</sup>
6 Connect Hanger Clip (not to be used in swimming hall environments)	0,7/m <sup>2</sup>	0,7/m <sup>2</sup>	0,7/m <sup>2</sup>	0,7/m <sup>2</sup>
7 Connect Inspection Hatch C3	as required	as required	as required	as required
8 Connect Hygiene Clip 20	11/m <sup>2</sup>	11/m <sup>2</sup>	7/m <sup>2</sup>	7/m <sup>2</sup>
9 Connect Hygiene Clip 40	11/m <sup>2</sup>	11/m <sup>2</sup>	7/m <sup>2</sup>	7/m <sup>2</sup>
10 Connect Channel Trim C3, fixed c300 (for 20 mm thickness)	as required	as required	as required	as required
11 Connect Channel Trim C3, fixed c300 (for 40 mm thickness)	as required	as required	as required	as required
12 Connect Anchor Screw C4	0,7/m <sup>2</sup>	0,7/m <sup>2</sup>	0,7/m <sup>2</sup>	0,7/m <sup>2</sup>
13 Connect Fixing Plate C4	0,7/m <sup>2</sup>	0,7/m <sup>2</sup>	0,7/m <sup>2</sup>	0,7/m <sup>2</sup>
Δ Min. overall depth of system: 150 mm	-	-	-	-
δ Min. demounting depth 20 mm: 150 mm	-	-	-	-
δ Min. demounting depth 40 mm: 170 mm	-	-	-	-

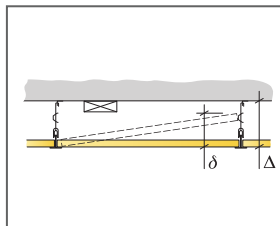

See Quantity Specification

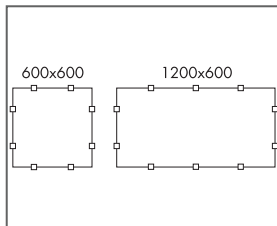

Arrangement of clips

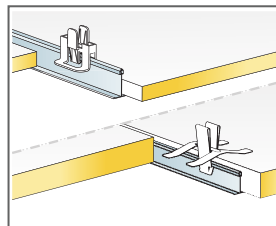

Clips for keeping tiles in position

Size, mm	Max live load (N)	Min load bearing capacity (N)
600x600	50	160
600x600	50	160
1200x600	50	160
1200x600	50	160

Live load/load bearing capacity