



## GENERATING SET MODEL

# GEPI150 Stage IIIA



## MAIN FEATURES

- Diesel engine
- Water-cooled
- Three phase generator
- Electronic speed governor
- Battery charger alternator
- Automatic voltage regulator
- **High customization possibility on all features**

## AVAILABLE VERSION

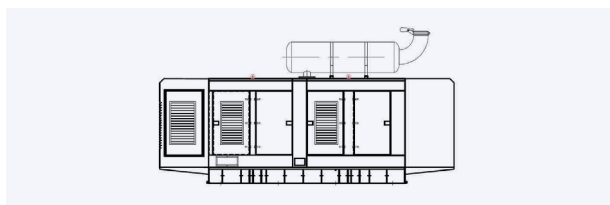

Super Silent

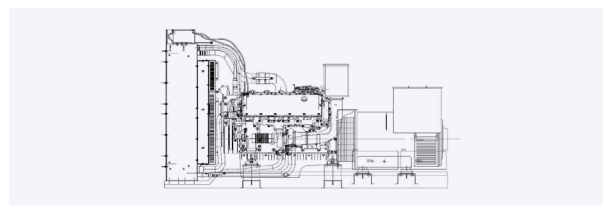

Open Type

## GENERATING SET DATA

## OPEN TYPE

### Prime Power (PRP):

According to ISO 8528-1:2005, Prime power is the maximum power which a generating set is capable of delivering continuously whilst supplying a variable electrical load when operated for an unlimited number of hours per year under the agreed operating conditions with the maintenance intervals and procedures being carried out as prescribed by the manufacturer.

### Limited-Time running Power (LTP):

According to ISO 8528-1:2005, Limited-time power is defined as the maximum power available, under the agreed operating conditions, for which the generating set is capable of delivering for up to 500h of operation per year with the maintenance intervals and procedures being carried out as prescribed by the manufacturers.

160

KVA PRP ISO8528-3046

1500/1800

RPM

400/230

Voltage

176

KVA LTP ISO8528-3046

50/60

Hz

0.8

Rated at power factor

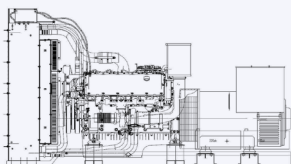

## OPEN TYPE

## ENGINE DATA

Engine data are shown for 1500 rpm speed:

Engine model	NEF N67TE1F Stage IIIA
Engine power PRP	131,5 kW
Engine power LTP	145,0 kW
Engine type	Diesel 4 strokes-cycle
Injection	Direct
Cylinders arrangement	6 - L
Displacement	6.7 liters

Cooling	Conditioned water
Compression ratio	17.5 : 1
Lube oil specification	ACEA E3/E5
Total oil capacity	12.0 litri
Total coolant capacity	10.5 litri
Air filters	Dry
Auxiliary voltage	12 Vdc
Battery n° and capacity	1 x 125 Ah

## AIR SYSTEM

Combustion Air Flow	630.0 m <sup>3</sup> /h
Cooling Air Flow	3.8 m <sup>3</sup> /s

## EXHAUST SYSTEM

Maximum allowed back pressure	5.0 kPa
Exhaust Gas Flow	782.0 kg/h
Exhaust Gas Temperature	600 °C

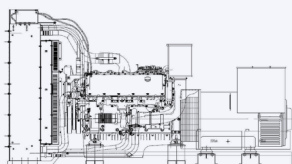

OPEN TYPE

## FUEL SYSTEM

Recommended fuel	N. A.			
Fuel consumption at load percentage	100 %	80 %	50 %	%
PRP	34.0 l/h	28.2 l/h	20.0 l/h	N. A.
LTP	N. A.	N. A.	N. A.	N. A.

## ALTERNATOR DATA

Number of poles	4
Bearing	Single
Insulation	H
Winding connections	Star series/Star parallel
Protection rating	IP23
Excitation	Self excited
Voltage regulator	A.V.R. (electronic)

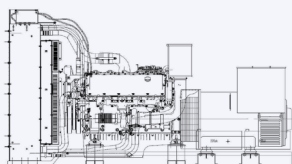

## DIMENSION AND DRAWING

## SUPER SILENT

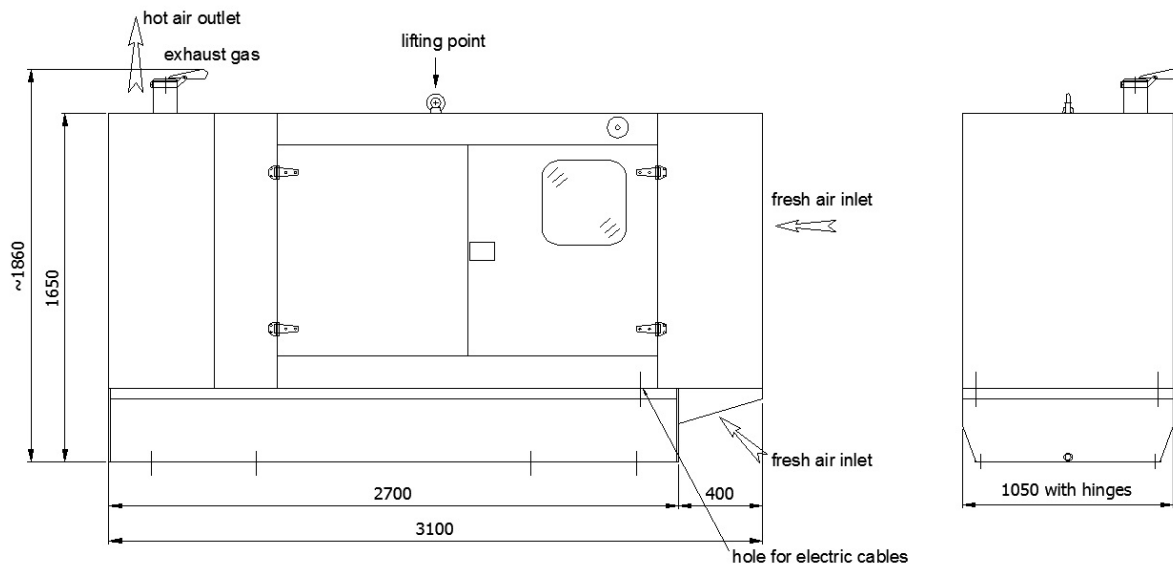

weight without fuel

2200 kg

Dimension and drawing reported on the pictures above may vary. Pictures are reported only for illustration purposes and refer to standard installation.

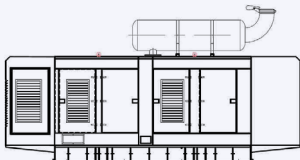



## SUPER SILENT

## COLOURS

All our soundproof parts, are manufactured with galvanize material coated with powder paint



Wide choice of colours and RAL:

RAL9010 is our standar colour. Others colours, available on request and with a price increase.

**RAL 9010**



Standard White

**RAL 9005**



Black: extra prices colour

**RAL 1023**



Yellow: extra prices colour

**RAL 6037**



Green: extra prices colour

**RAL 3020**



Red: extra prices colour

**RAL 5017**



Blue: extra prices colour

**RAL 7033**



Cement Grey: extra prices colour

**RAL 8004**



Brown Rust: extra prices colour

## SUPER SILENT

### SOUNDPROOF CANOPY PLUS:

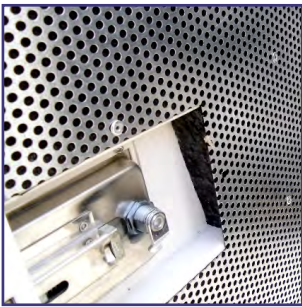

**Internal doors side with holed metal sheet**  
For noise containment and limitation

**Lockable doors with keys**  
For safety increasing

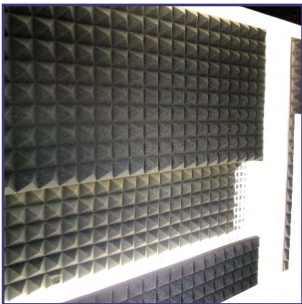

**Soundproof materials**



**Large maintenance area and extensive level of customization possible on canopy size**  
Very simple access to the maintenance points



**Stone wool insulations**  
For the hottest surfaces protection

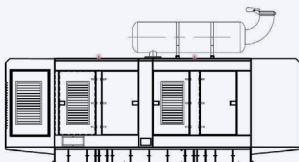
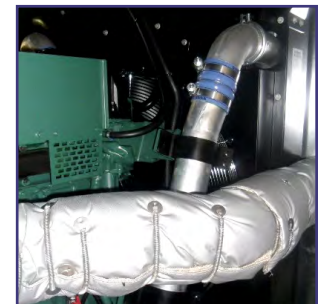

## SUPER SILENT

### SOUNDPROOF:



Lifted generator,  
ready to deliver



All our soundproof canopies,  
have one or more lifting  
points that allow a very  
simple lifting operation

All our soundproof canopies, present air inlets outlets that may be placed in a variety of locations depending on the requirements

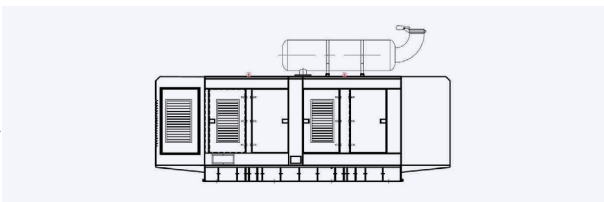
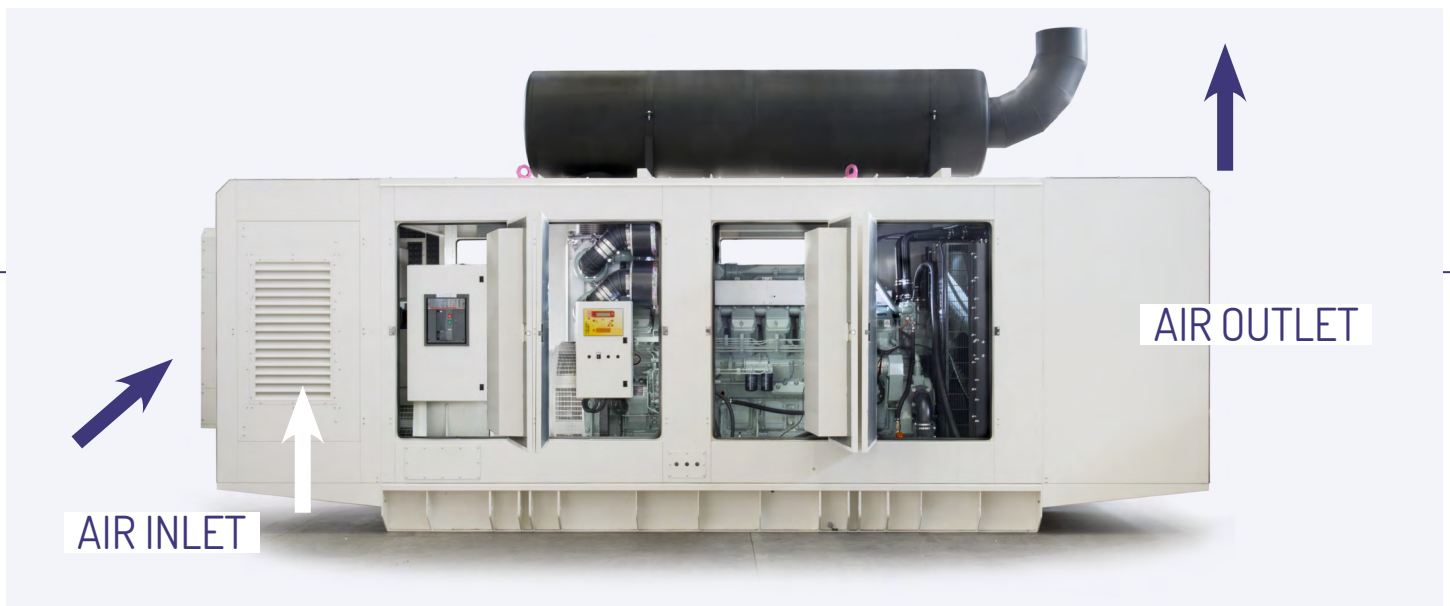





## SUPER SILENT

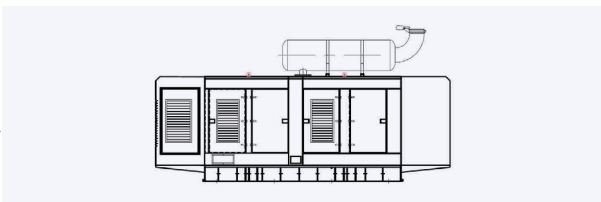
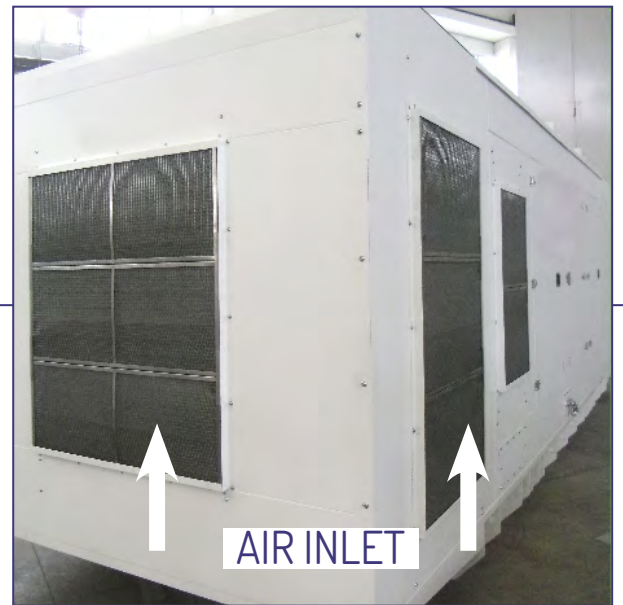
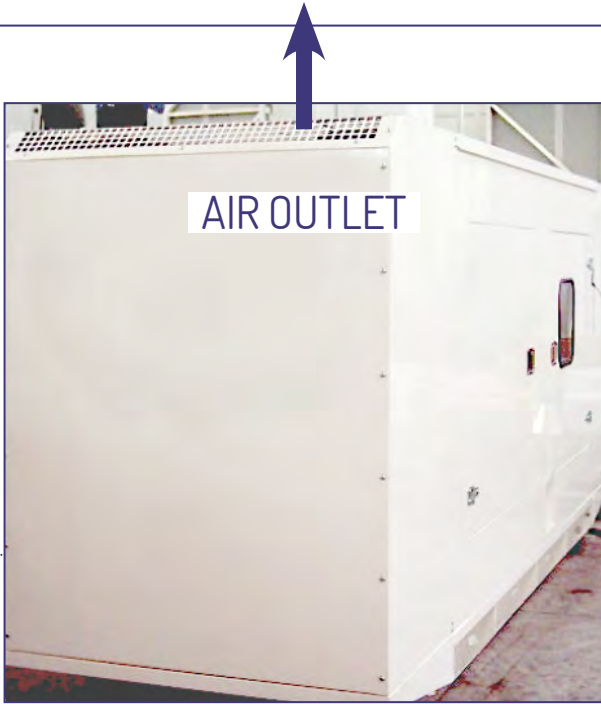

## SUPER SILENT

In all soundproof canopies, there are predispositions for external fuel tank



and for customers cable entrance

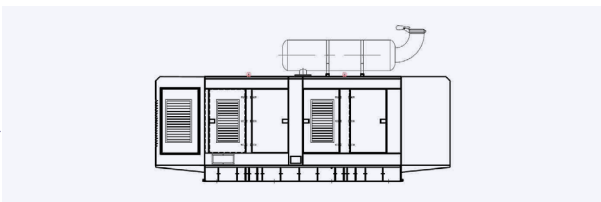
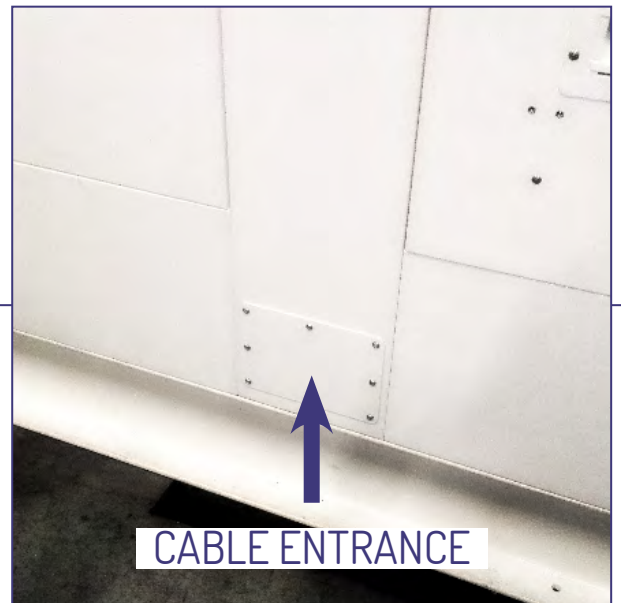
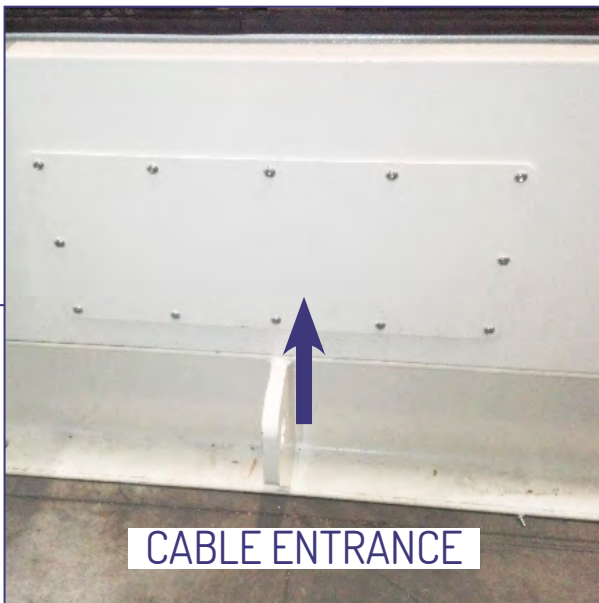

## DIMENSION AND DRAWING

## OPEN TYPE

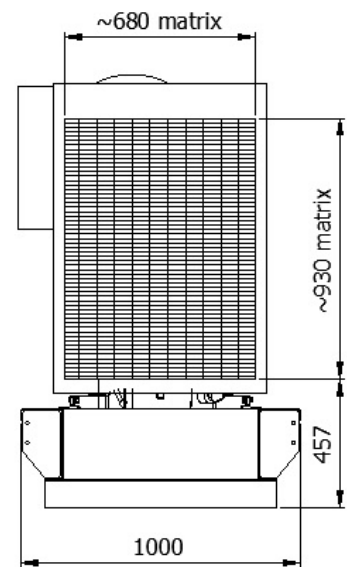
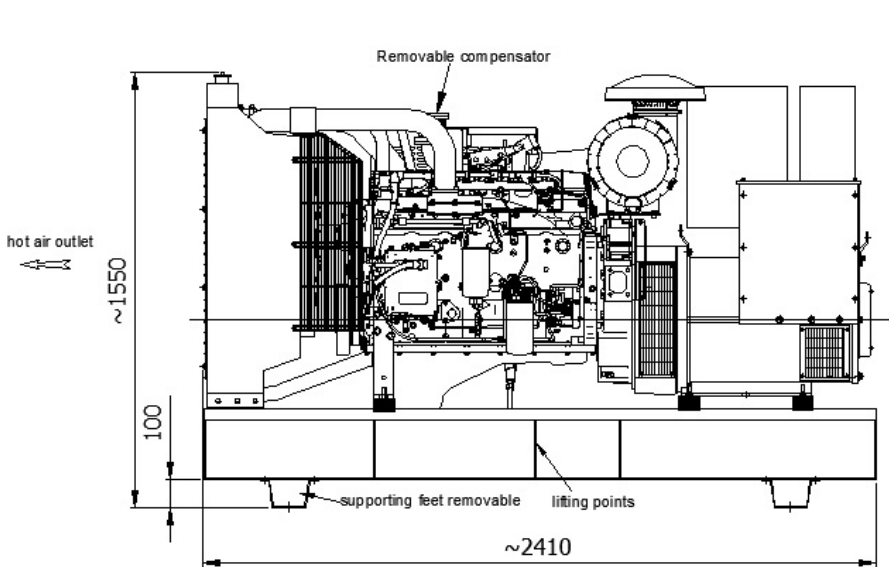

weight without fuel	1400 kg
---------------------	---------

Weight of the generating sets, vary in function of the equipment. The correct weight can be calculated only when the order supply is defined.

Daily tank, if provided, is situated into the generating set base and is equipped with precision fuel level sensor and any other required sensor. Daily tank is provided with many connection predispositions

Daily tank form and size are perfectly customizable to meet customer needs

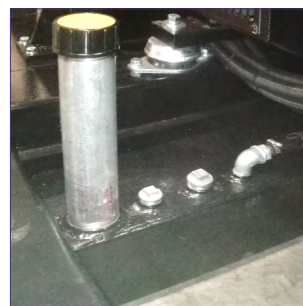
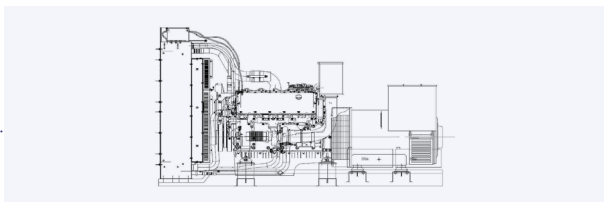

## CONTROL PANEL

### 6000S

SERIES

**Auto start modules:** used to control, operate the genset and engages the generator contactor.



Control unit CAM120

### 7000S

SERIES

**Auto start and auto mains failure control modules:** automatic emergency intervention control units. They commands the mains and generator contactors to supply the user.

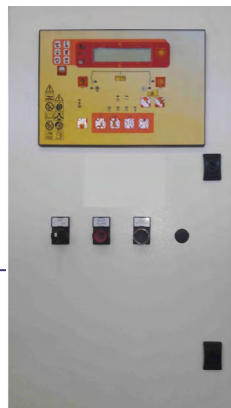

Control unit CAM684, CAM 685

## CONTROL PANEL

### 7100S

SERIES



Control unit IntelliLite AMF25

### 7300S

SERIES

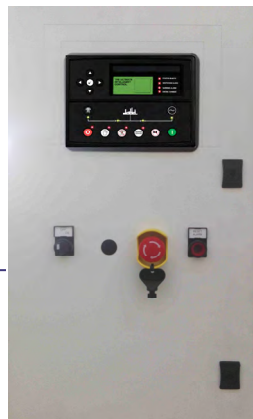

Control unit DSE7320MKII

## CONTROL PANEL

8000S  
8100S

SERIES

[genset parallels and  
parallel to mains]

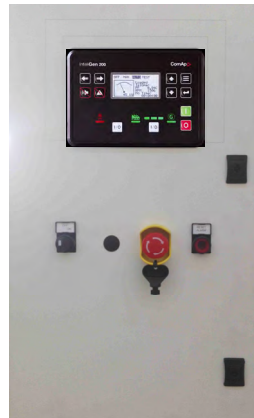

Control unit IntelliGen IG200

**Synchronising auto start load share control module:** control units used to manage the parallel to mains and the multi parallel gensets.

## STANDARD AND OPTIONAL FEATURES

---

- Power panel with automatic circuit breaker
  - Electrical power wirings between circuit breaker and alternator
  - Engine preheating system
  - Alternator preheating system
  - Fuel preheating system
  - Fuel tank
  - Fuel level probe
- 
- Fuel automatic load pump
  - Emergency stop button
  - Differential relay
  - Oil extraction pump
  - Reinforced lifting points
  - Alarms system
  - Exhaust gas system silencer
  - Antivibration shock absorber
  - Others kit or optional features established during order
-